

Rozdzielnica SB-103505



Budowa symbolu zamówieniowego

SB-103505	S	<input type="text"/> - <input type="text"/>	
			Stopień ochrony
			54 IP54
			66 IP66
			Nr wykonania rozdzielnicy
			0000, 0010, 0020, 0030, 0040
			0050, 0060, 0070, 0080, 0090
			0100, 0110, 0120, 0130, 0140
			0150
			Typ gniazda
S			Skośne*

Istnieje możliwość zamówienia gniazd jednofazowych w wersji SCHUKO. Należy wtedy dopisać „S”, np. SB-103505-S0050-54-S.

* Standardowo montowane są gniazda skośne. Można zamówić gniazda proste wpisując literę „P” zamiast „S”.

Dane techniczne

Napięcie znamionowe	400/230 V (50 Hz)
Napięcie znamionowe izolacji U_i	500 V
Napięcie znamionowe udarowe wytrzymałalne U_{imp}	4 kV
Prąd znamionowy zestawu I_{nA}	32/63 A
Stopień ochrony	IP54 / IP65 / IP67
Klasa ochronności	II
Przekrój przewodów przyłączeniowych	maks. $5 \times 6 \text{ mm}^2$ (PG21) dla 32 A maks. $5 \times 16 \text{ mm}^2$ (PG29) dla 63 A
Ilość modułów	10

Wymiary

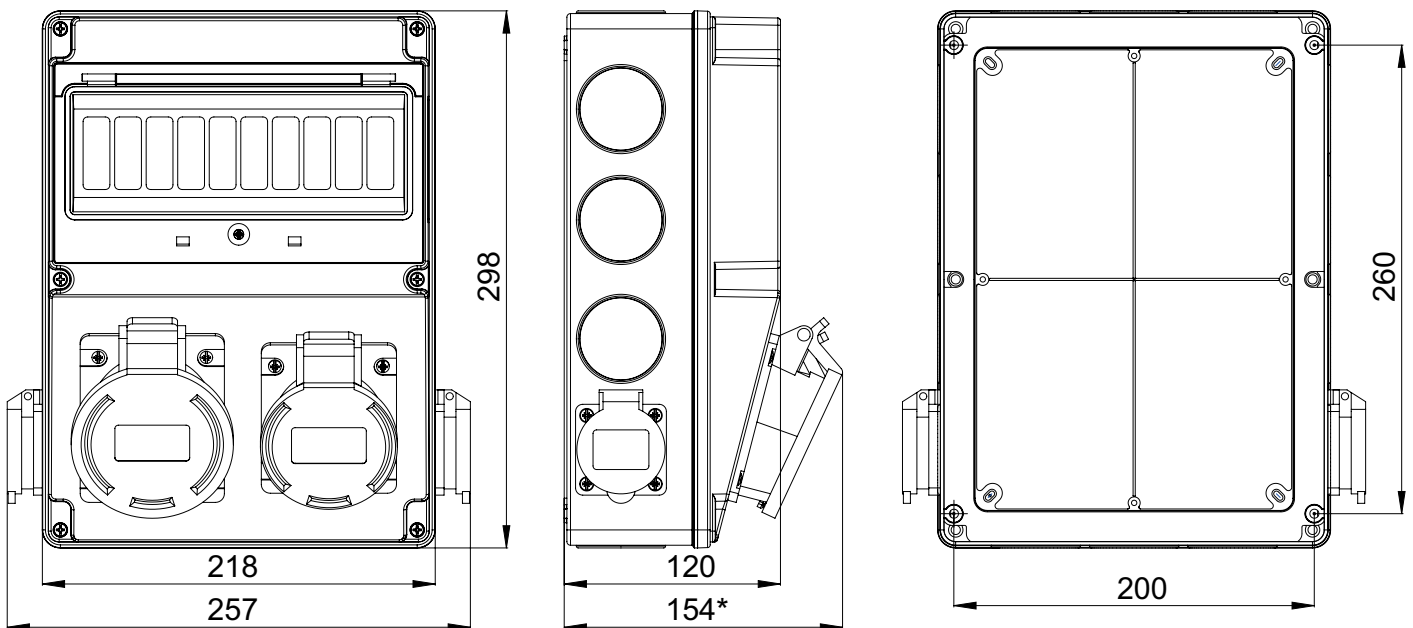

*) Dla gniazda 32 A

Wykonania

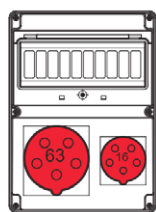

SB-103505-S0070

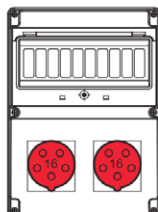

SB-103505-S0010

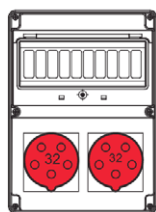

SB-103505-S0020

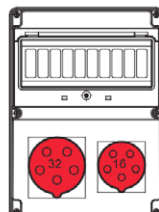

SB-103505-S0030

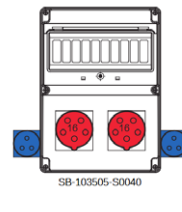

SB-103505-S0040

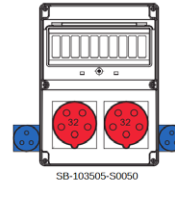

SB-103505-S0050

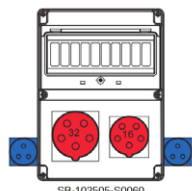

SB-103505-S0060

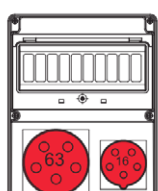

SB-103505-S0070

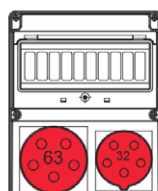

SB-103505-S0080

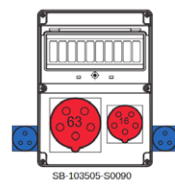

SB-103505-S0090

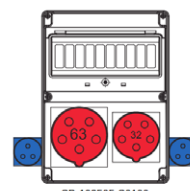

SB-103505-S0100

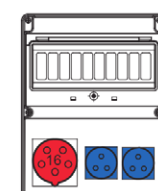

SB-103505-S0110

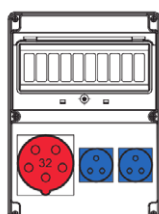

SB-103505-S0120

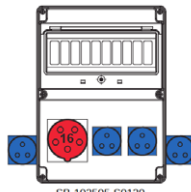

SB-103505-S0130

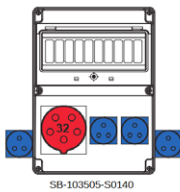

SB-103505-S0140

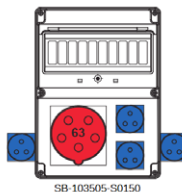

SB-103505-S0150