

Rozdzielnica SB-007005



Ordering code

SB-007005-	S	<input type="text"/>	-	<input type="text"/>
				Degree of protection
				54 IP54
				67 IP67
				Assembly number of distribution board
				0000, 0010, 0020, 0030, 0040
				0050
				Typ gniazda
	S			Skośne*

Istnieje możliwość zamówienia gniazd jednofazowych w wersji SCHUKO. Należy wtedy dopisać „S”, np. SB-007005-S ... -S.

* Standardowo montowane są gniazda skośne. Można zamówić gniazda proste wpisując literę „P” zamiast „S”.

Technical data

Rated voltage	400/230 V (50 Hz)
Rated insulation voltage U_i	500 V
Rated withstand impulse voltage U_{mp}	4 kV
Prąd znamionowy zestawu I_{nA}	16/32 A
Degree of protection	IP54 / IP67
Protection class	II
Wire gauge	maks. $5 \times 6 \text{ mm}^2$ (PG21)

Dimensions

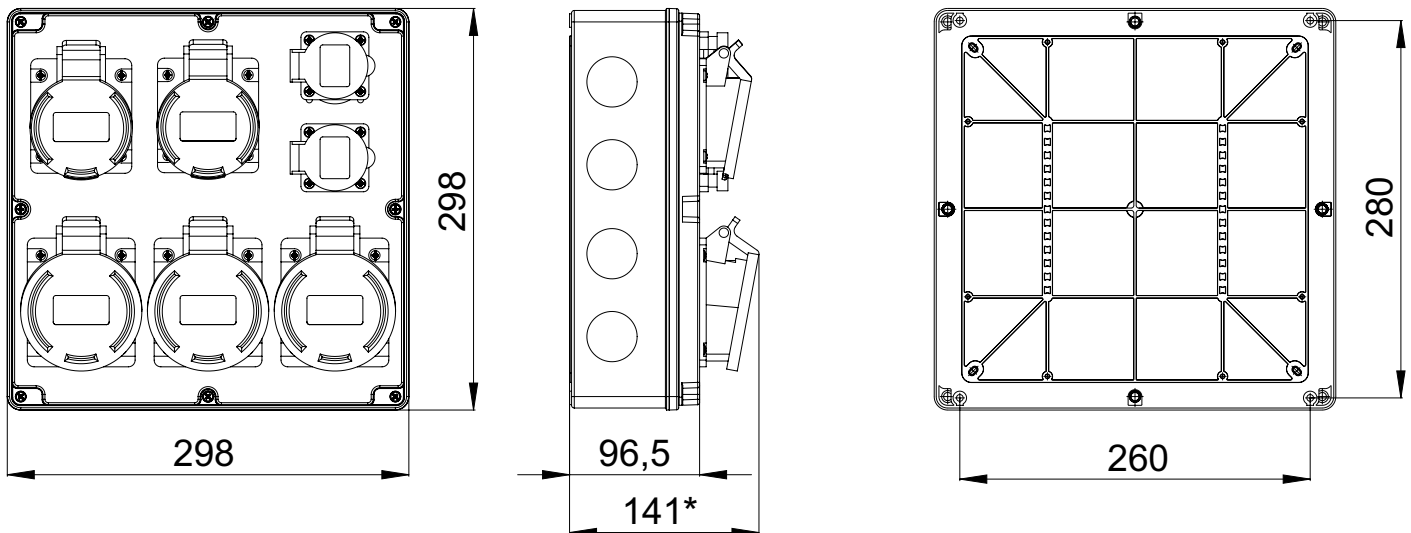

*) Dla gniazda 32 A

Assemblies

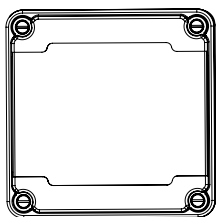

SB-001005-P0000

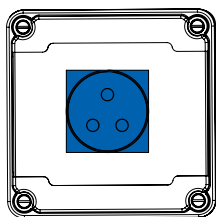

SB-001005-P0010

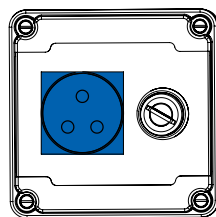

SB-001005-P0020